

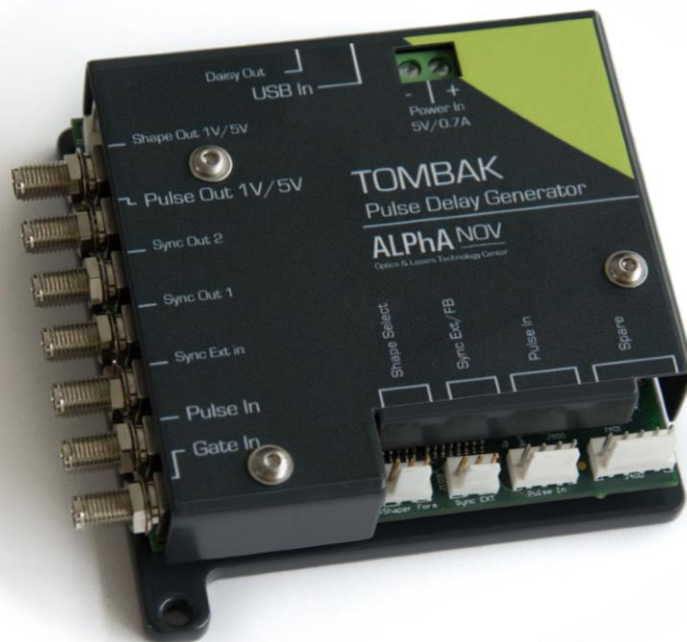

Pulse-Picker

TOMBAK



Synchronization signals is available on this module. A signal (internally generated or external) can be synchronized with an external reference signal connected to Pulse-In connector. The output delay from input and the pulse width are software adjustable.

Main features

| | |
|--|--|
| Adjustable pulse width <ul style="list-style-type: none"> ▪ resolution (for pulse width [5ns – 510ns]) ▪ resolution (for pulse width [511ns – 2⁶²ns]) | [5ns – 2 ⁶² ns] 2ns 5ns |
| Adjustable pulse delay <ul style="list-style-type: none"> ▪ resolution | [70ns – 2 ⁶² ns] 10ps |
| Input Ext-In Voltage <ul style="list-style-type: none"> ▪ Logic Low ▪ Logic High | [0-0.8V] [1.7-3.3V] |
| Input PulseIn voltage | 30 mV – 3,3V |
| Input maximum frequency | 200 MHz |
| Output Voltage | 1 / 3,3 / 5 Volts (hardware setup) |
| Output maximum frequency | 20 MHz |

Timing diagram

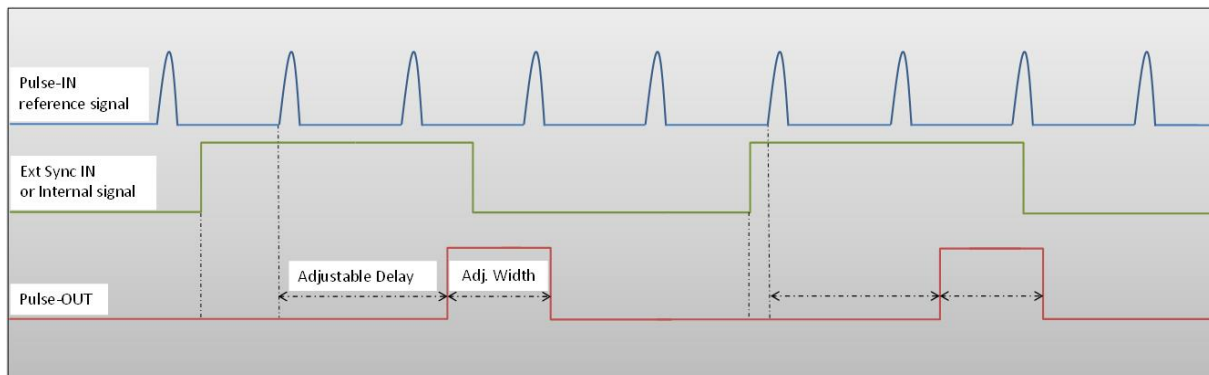

Figure 1 : External or internal signal synchronized with Pulse-In signal.

Synoptic

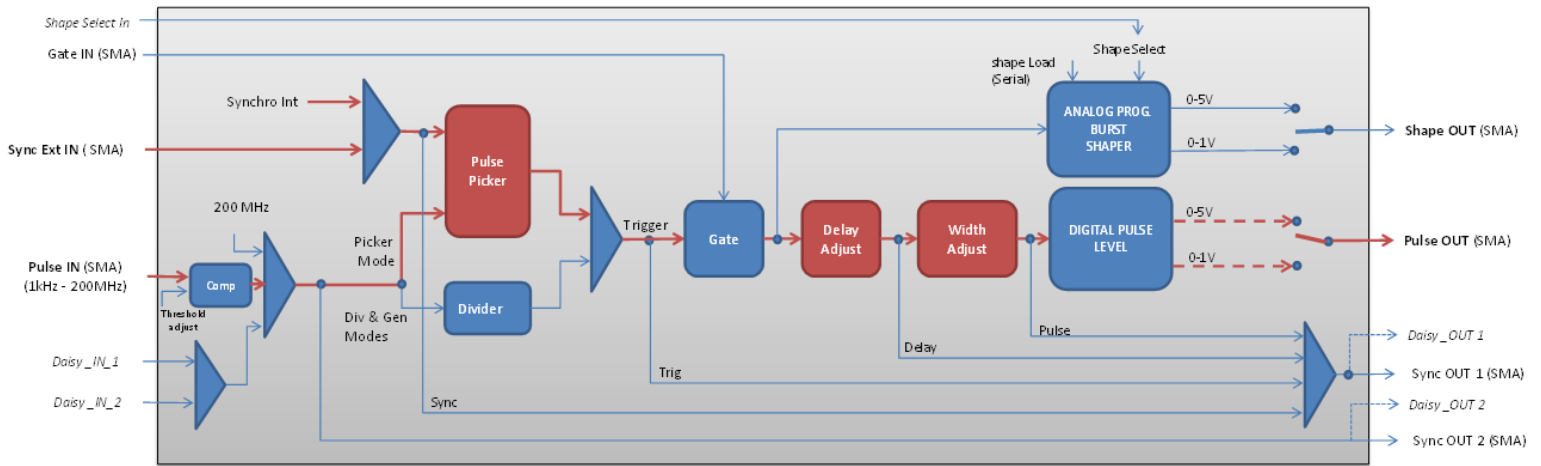
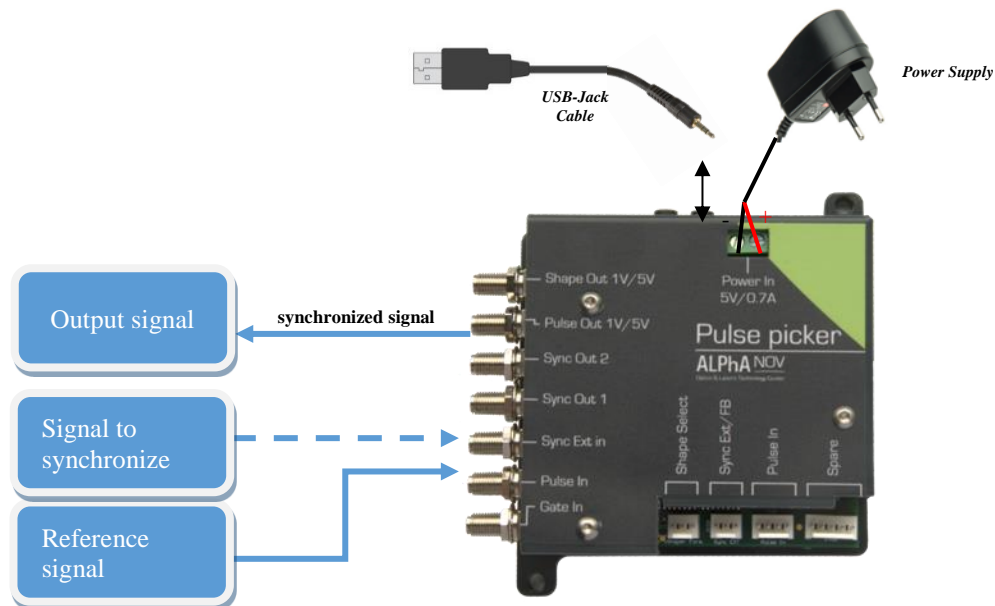

Figure 2 : Main firmware features used in synchronization mode

Cabling

1. Plug the USB-Jack cable in the “*USB In*” connector
2. Plug the signal to synchronize in the “*Sync Ext in*” SMA connector. (only for external signal synchronization). If signal to synchronize is internally generated, no signal needed on “*Sync Ext in*”.
3. Plug the reference signal (i.e. the signal on which “*Sync Ext In*” signal or “*internal signal*” will be synchronized with) in the “*Pulse In*” SMA connector
4. The synchronized signal will output on the “*Pulse Out*” SMA connector
5. Finally, plug the power supply to the “*Power In*” connector to power on the board



1.1.1.1 Software configuration

Launch the ALPhANOV Control Software and click on *Connect* to start the Tombak hardware detection. The software automatically detects the Pulse-Picker board.

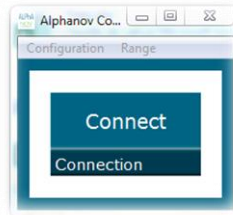

A window will appear for each Tombak connected to the computer.

The main configuration windows must be configured as follow :

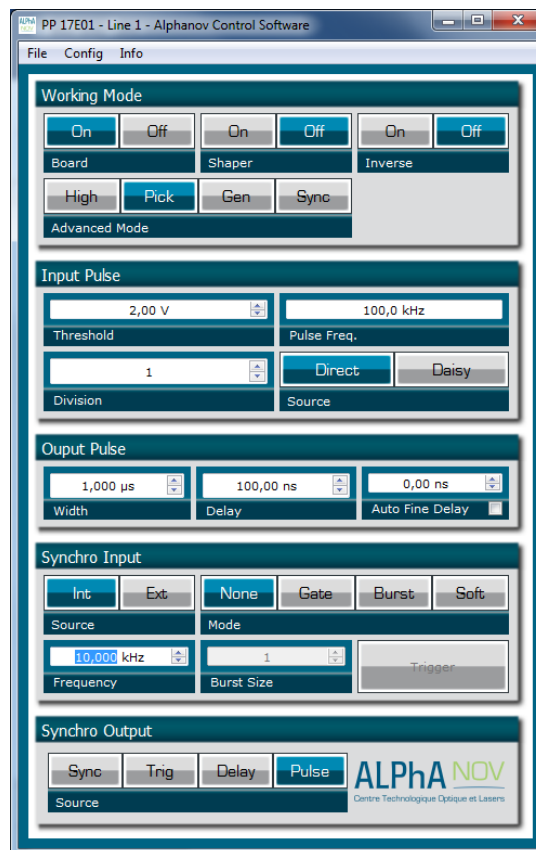

- Working Mode window :
 - Set the **Board** On
 - Set the **Shaper** button to **Off**
 - Set the **Inverse** button to **Off** unless you need to invert the output signal
 - Set **Advanced Mode** to **Pick**

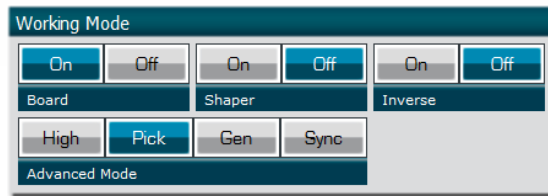

- Input pulse window :
 - Configure the **Threshold** voltage so that the input **pulse frequency** is detected and equal to your pulse generator system
 - Set the **Division** factor to **1**
 - Set the input pulse **Source** to **Direct**



- Output Pulse window :
 - Choose the output **delay value**
 - Choose the output **pulse width**
 - **Auto Fine Delay** may be let in auto mode

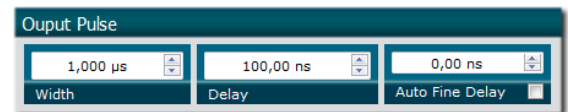

- Synchro input windows :
 - Source :
 1. Set **Int** to synchronize an internal generated signal with Pulse-In signal.
 2. Set **Ext** to synchronize an external signal (connected to Ext-In connector) with Pulse-In signal.
 - Mode : None
 - Frequency :
 1. If internal source is selected, set the output signal **Frequency** you need to synchronize.
 2. If external source is selected, **Frequency** shows the input Ext-In signal frequency
 - Burst size : not used in this mode

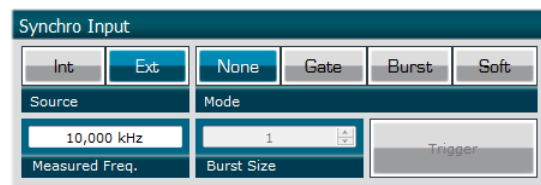
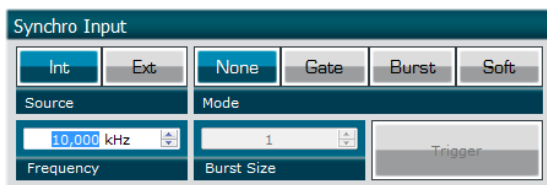

- Synchro output window (default settings) :
 - Source : Pulse

