

Application Note *How to use the TOMBAK as a frequency divider*

Multiboard Series

TOMBAK : Synchronization electronic board



How to use the TOMBAK as a frequency divider

Pre-requirement: Before using the TOMBAK board, make sure you followed all the instructions mentioned in the Operating Manual

1. Presentation

The board provides a software configurable frequency divider with specific delay and pulse width signal from a reference pulse signal.

2. Timing Diagram

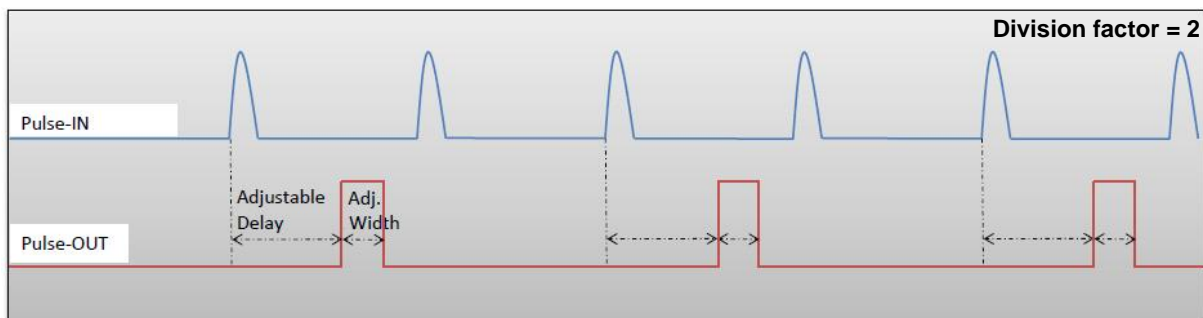

Figure 1 : Frequency divided, delayed and pulse width adjusted signal from input to output

3. Synoptic

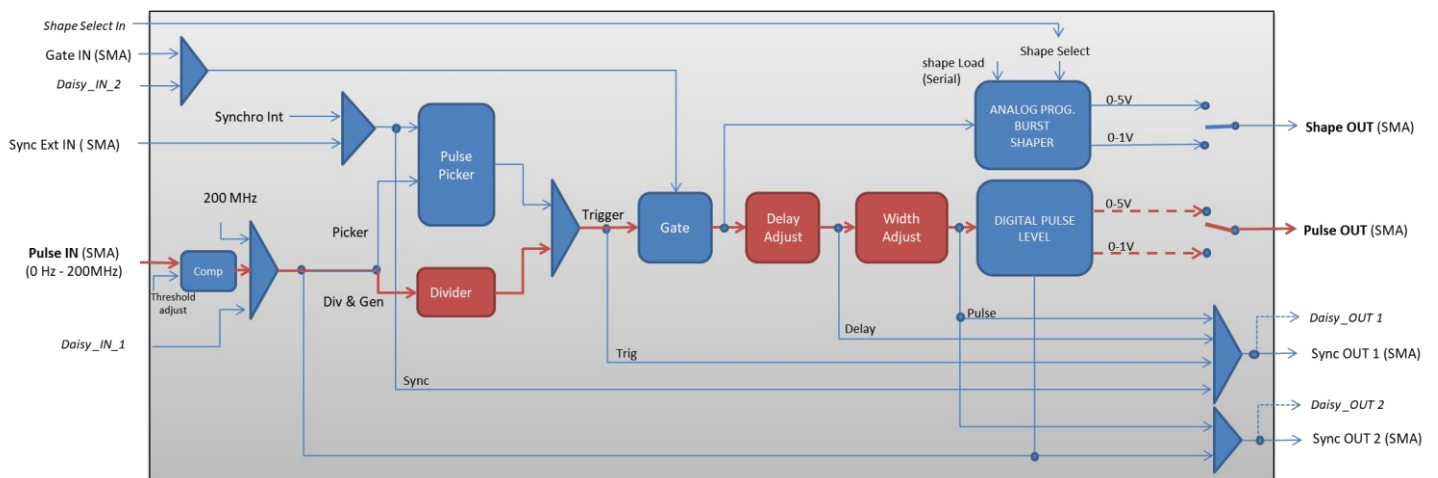
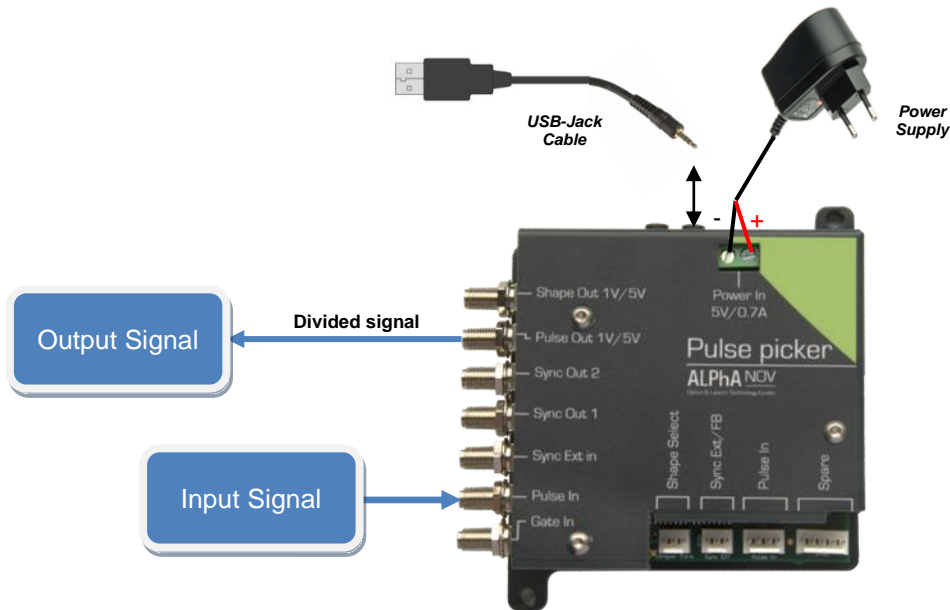

Figure 2 : Main firmware features used in frequency divider mode

4. Cabling

1. Plug the USB-Jack cable in the “USB In” connector
2. Plug the signal generator (i.e. the signal you want to delay) in the “Pulse In” SMA connector
3. The software adjustable delay and pulse width signal will output on the “Pulse Out” SMA connector
4. Finally, plug the power supply to the “Power In” connector to power on the board



5. Software configuration

Launch the ALPhANOV Control Software and click on *Connect* to start the TOMBAK hardware detection. The software automatically detects the TOMBAK board.

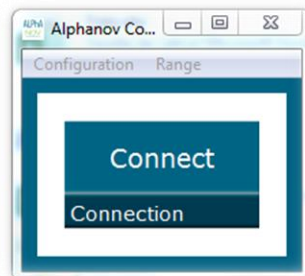

A window will appear for each TOMBAK connected to the computer.

The main configuration windows must be configured as follow :

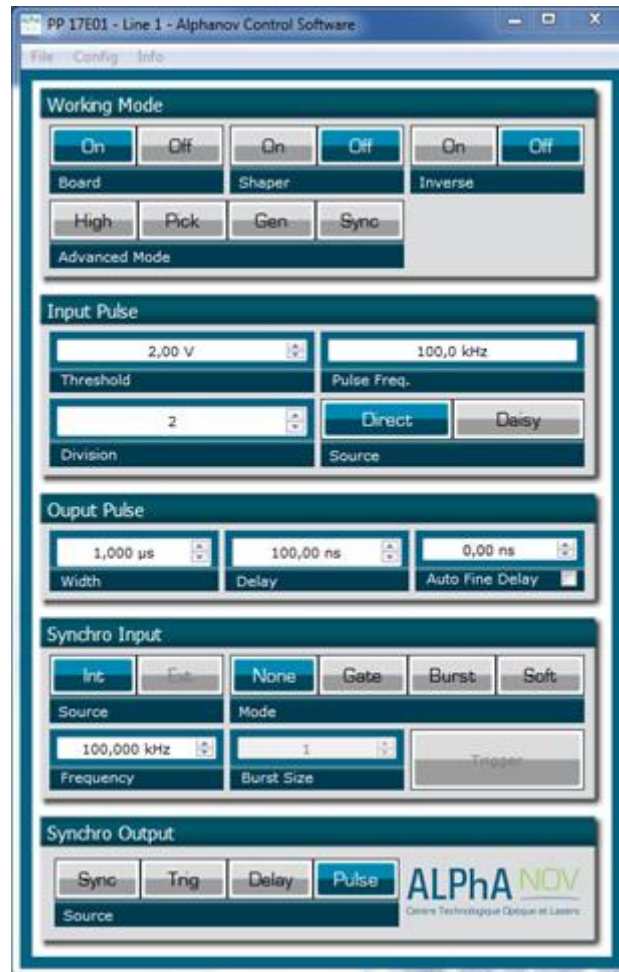

- Working Mode window :
 - Set the **Board On**
 - Set the **Shaper** button to **Off**
 - Set the **Inverse** button to **Off** unless you need to invert the output signal
 - Unset all **Advanced Mode**

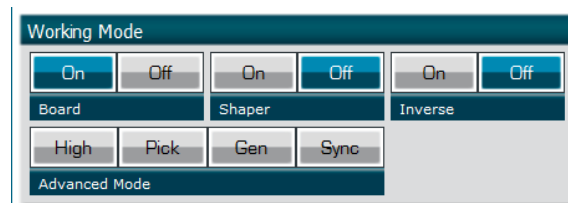

- Input pulse window :
 - Configure the **Threshold** voltage so that the input **pulse frequency** is detected and equal to your pulse generator system
 - Set the **Division** factor **according to your application**
 - Set the input pulse **Source** to **Direct**



- Output Pulse window :
 - Choose the output **delay** value
 - Choose the output **pulse width**
 - **Auto Fine Delay** may be let in auto mode

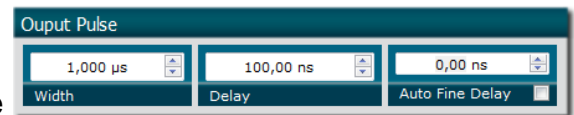

- Synchro input windows :
 - Source : not used in this mode
 - Mode : None
 - Frequency : not used in this mode
 - Burst size : not used in this mode

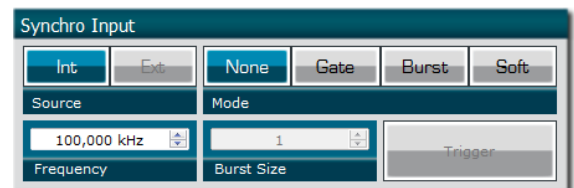

- Synchro output window (default settings) :
 - Source : Pulse

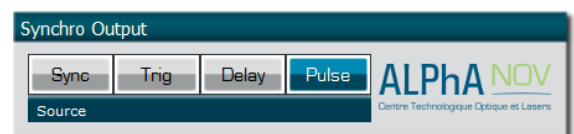

Don't forget to save the settings by clicking on the "Save" button in the bar menu.

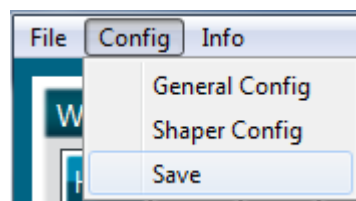

6. Main features

Frequency divider factor	[1 – 10 ⁹]
Adjustable pulse width ⇒ resolution (for pulse width [5ns – 510ns]) ⇒ resolution (for pulse width [511ns – 2 ⁶² ns])	[5ns – >>1000s] 2ns 5ns
Adjustable pulse delay ⇒ resolution	[70ns – >>1000s] 10ps
Jitter ⇒ for delay < 570ns & pulse width < 510ns ⇒ for any other delay & pulse width	<200 ps RMS 1.5 ns RMS
Input PulseIn voltage	30 mV – 3,3V
Input maximum frequency	200 MHz
Output Voltage	1 / 3,3 / 5 Volts (hardware setup)
Output maximum frequency	20 MHz