

**Application Note**  
***How to use the TOMBAK  
as a voltage level converter  
(SYNC Mode)***

**Multiboard Series**

*TOMBAK : Synchronization electronic board*



# How to use the TOMBAK as a Voltage Level Converter (SYNC Mode)

*Pre-requirement: Before using the TOMBAK board, make sure you followed all the instructions mentioned in the Operating Manual*

## 1. Presentation

The board can be used as a voltage level converter in every mode that used the Pulse\_In signal as a reference signal. However, SYNC mode is a specific mode that gives extended performance to the voltage converter feature (higher frequency, lower jitter, lower insertion delay...).

An additional “Autofine delay” can be added which adds a 0-10ns delay while keeping a very short insertion delay and ultra-low Jitter.

## 2. Timing & voltage level Diagram

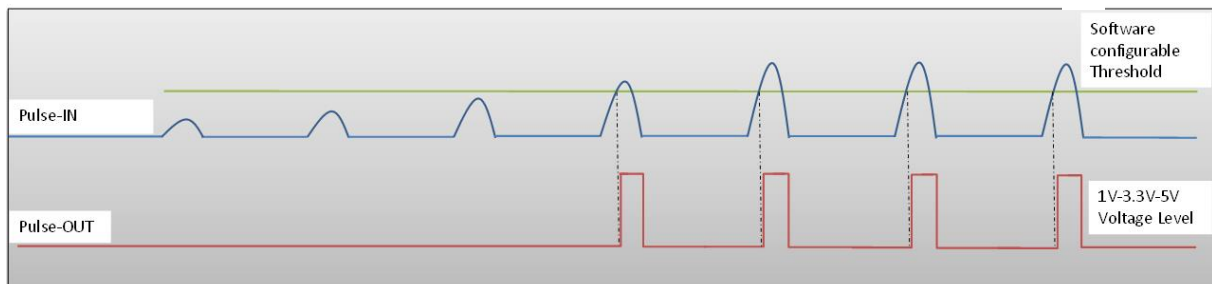

Figure 1 : Pulse In detection signal with software adjustable threshold

## 3. Synoptic

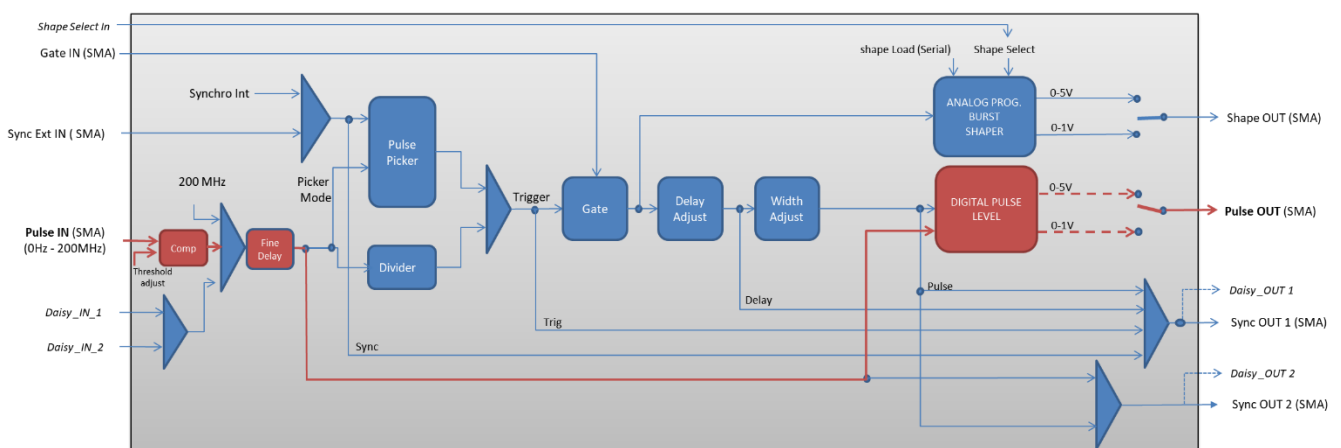
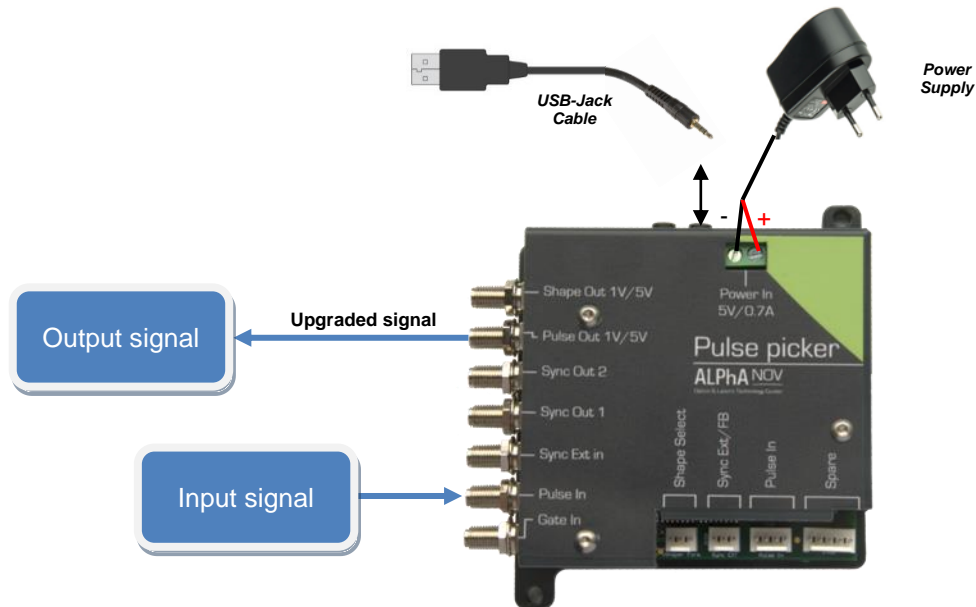

Figure 2 : Main firmware features used in Voltage Level Converter

## 4. Cabling

1. Plug the USB-Jack cable in the “*USB In*” connector
2. Plug the signal you want to convert in the “*Pulse In*” SMA connector
3. The upgraded signal will output on the “*Pulse Out*” SMA connector
4. Finally, plug the power supply to the “*Power In*” connector to power on the board



## 5. Software configuration

Launch the ALPhANOV Control Software and click on *Connect* to start the TOMBAK hardware detection. The software automatically detects the TOMBAK board.

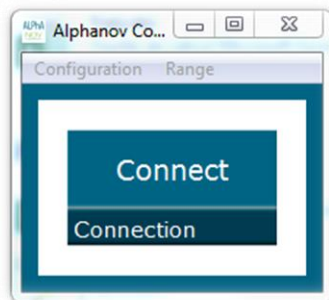

**A window will appear for each TOMBAK connected to the computer.**

The main configuration windows must be configured as follow :

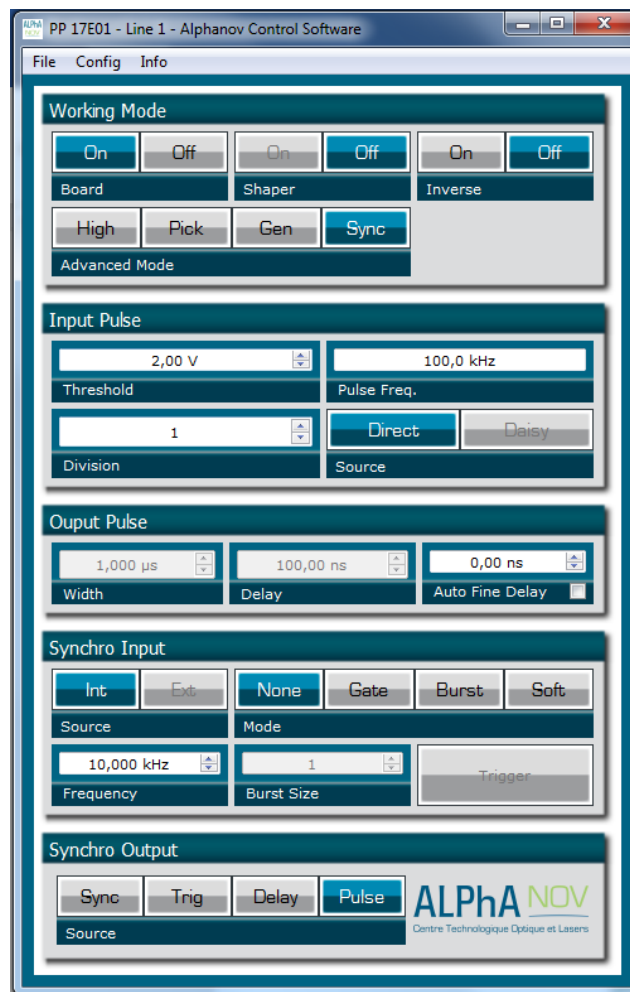

- Working Mode window :
  - Set the **Board** On
  - Set the **Shaper** button to **Off**
  - Set the **Inverse** button to **Off** unless you need to invert the output signal
  - Set **Advanced Mode** to **Sync**

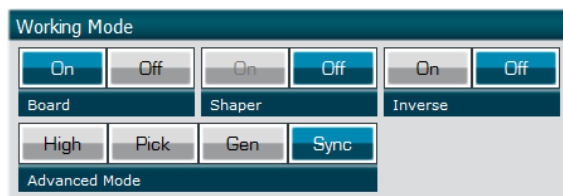

- Input pulse window :
  - Configure the **Threshold** voltage so that the input **pulse frequency** is detected and the same as your pulse generator system
  - Set the **Division** factor to **1**
  - Set the input pulse **Source** to **Direct**

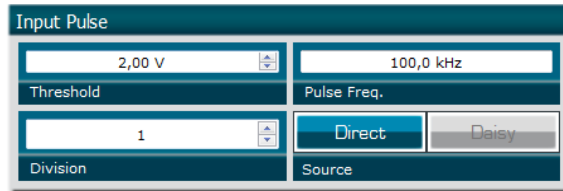

- Output Pulse window :
  - Choose the output **delay value**
  - Choose the output **pulse width**
  - **Auto Fine Delay** may be let in auto mode (this generates an additional adjustable delay in the 0-10ns range)

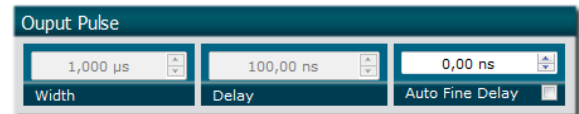

- Synchro input windows (default settings) :
  - Source : not used in this mode
  - Gate Mode : None
  - Frequency : not used in this mode
  - Burst size : not used in this mode

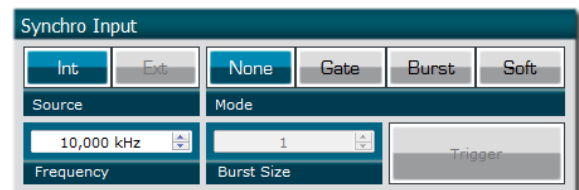

- Synchro output window (default settings) :
  - Source : Pulse

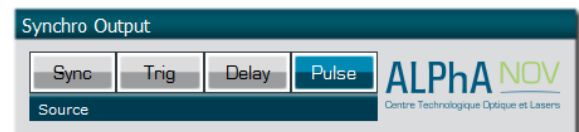

Don't forget to save the settings by clicking on the "Save" button in the bar menu.

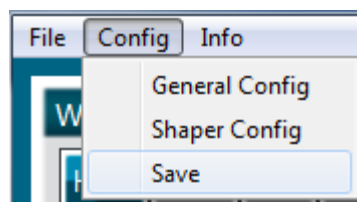

## 6. Main features

Input PulseIn voltage (software adjustable threshold)	30 mV – 3,3V
Input/output maximum frequency	150 MHz
Minimum insertion delay (fine delay deactivated) (see fig 2)	12 ns
Minimum insertion delay (0-10ns fine delay) (see fig 2)	15 ns
Output Voltage	1 / 3,3 / 5 Volts (hardware setup – see user manual for selecting it)